

SONOFF

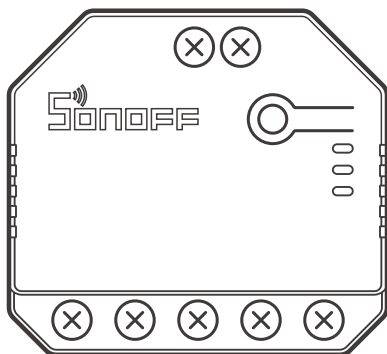

DIY DUAL

User manual V1.2



2-Gang Wi-Fi Smart Switch

· 中文-----	1-8	· English-----	9-16
· Deutsch-----	17-24	· Español-----	25-32
· Français-----	33-40	· Italiano-----	41-48
· Русский язык-----	49-56	· Português-----	57-64

· FCC Warning-----	65		

2. Wiring instruction

⚠ Do not pull the wire directly from the live wire to the S1/S2 external switch! Must from device.

Motor mode:

① Momentary switch:

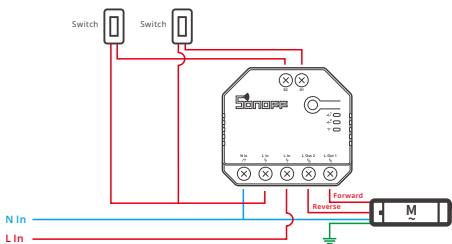

⚠ Connect to S1 or S2 for smart control of connected devices; connect to S1 and S2 for two-way smart control.

② Dual relay momentary switch/3-gang rocker switch:

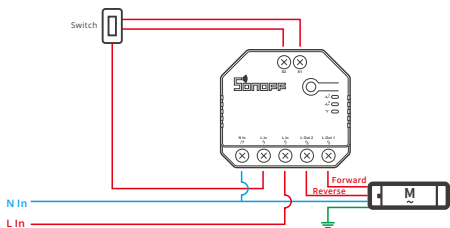

Light fixture wiring instruction:

- ① To enable dual relay control, S1 and S2 are required to connect the push button switch in the pulse mode or the rocker light switch in the edge mode:

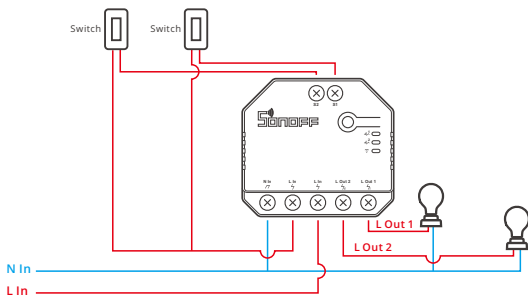

- ② Connect SPDT switches in the edge mode to reach double two-way control:

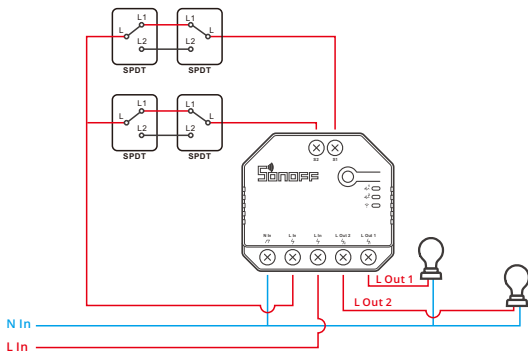

③ Connect dry contact sensors in the following mode:

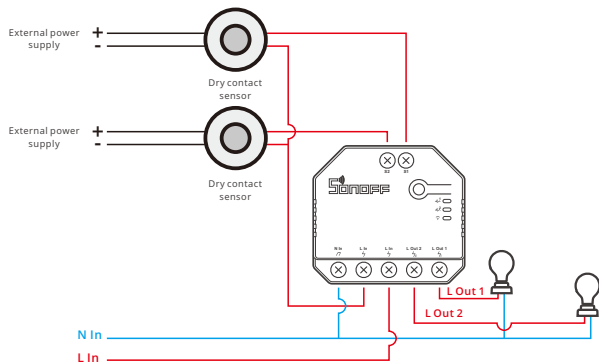

- ⚠ Make sure the neutral wire and live wire connection is correct.
- ⚠ The device still works normally if no a physical light switch is connected to S1/S2.
- ⚠ If S1/S2 is connected to a physical light switch, the corresponding working mode is required in eWeLink APP to select for normal use.

3. Download the eWeLink APP



Android™ & iOS

4. Power on

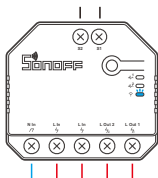

After powering on, the device will enter the bluetooth pairing mode during the first use. The Wi-Fi LED indicator changes in a cycle of two short and one long flash and release.

ⓘ The device will exit the bluetooth pairing mode if not paired within 3mins. If you want to enter this mode, please long press the manual button for about 5s until the Wi-Fi LED indicator changes in a cycle of two short and one long flash and release.

5. Add the device

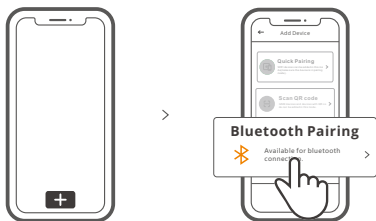

Tap "+" and select "bluetooth pairing", then operate following the prompt on the APP.

Compatible Pairing Mode

If you fail to enter Bluetooth Pairing Mode, please try "Compatible Pairing Mode" to pair.

Long press Pairing button for 5s until the Wi-Fi LED indicator changes in a cycle of two short flashes and one long flash and release. Long press Pairing button for 5s again until the Wi-Fi LED indicator flashes quickly. Then, the device enters Compatible Pairing Mode.

For Android system:

Tap "+" and select "Compatible Pairing Mode" on app, Please follow the app prompts.

For iOS system:

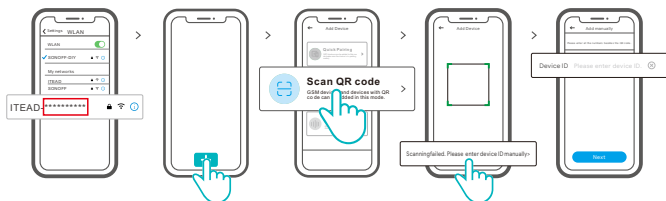

- ① When the device is in the compatible mode, please record the device ID ITEAD-*****, which can be found in the Wi-Fi list of the mobile phone.
- ② Enter Wi-Fi password, tap "Next" and then "Connect". Select Wi-Fi SSID with ITEAD-***** and enter the password 12345678, and then go back to eWeLink app and tap "Next". Be patient until pairing completes.

Specifications

Model	DUALR3, DUALR3 Lite
Input	100-240V AC 50/60Hz 15A Max
Output	100-240V AC 50/60Hz
Resistive Load	2200W/10A/Gang 3300W/15A/Total
Motor Load	10-240W/1A
Wi-Fi	IEEE 802.11 b/g/n 2.4GHz
Frequency range	2400-2483.5Mhz
Version Information	Hardware Versions: V1.0 Software Versions: V1.0
Maximum RF output power	Wi-Fi:19dBm(ERP) BLE:4dBm(ERP)
Operating systems	Android & iOS
Number of gangs	2-Gang
Working temperature	-10°C~40°C
Material	PC V0
Dimension	54x49x24mm

Wi-Fi LED indicator status instruction

LED indicator status	Status instruction
Flashes (one long and two short)	Bluetooth Pairing Mode
Keeps on	Device is connected successfully
Flashes quickly	Compatible Pairing Mode
Flashes quickly once	Unable to discover the router
Flashes quickly twice	Connect to the router but fail to connect to server
Flashes quickly three times	Upgrading

Working Mode

After pairing, select the corresponding mode from switch, motor and meter modes according to the connected device.

Switch Mode:

Control two output loads independently.

Motor Mode:

Suitable for four-wire tubular motors such as curtain and roller blind motor.

Meter Mode (DUALR3) :

The relay keeps on, and can not be turned off. Focusing on power metering.

Switch Network

If you need to change the network, long press the pairing button for 5s until the Wi-Fi LED indicator changes in a cycle of two short and one long flash and release, then the device enters Bluetooth pairing mode and you can pair again.

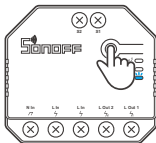

Factory Reset

Deleting the device on the eWeLink app indicates you restore it to factory setting.

Common Problems

Fail to pair Wi-Fi devices with eWeLink APP

1. Make sure the device is in pairing mode.
The device will automatically exit the pairing mode if not paired within 3mins.
2. Please turn on the location service on your mobile phone and give the permission.
Before choosing the Wi-Fi network, the location service should be turned on and the permission is given. Location information permission is used to obtain Wi-Fi list information. If you tap "Disable", the device will not be added.
3. Make sure your Wi-Fi network runs on the 2.4GHz band.
4. Make sure you entered a correct Wi-Fi SSID and password, no special characters contained. A wrong password is a very common reason for pairing failure.
5. You may get the device close to the router for a good signal transmission while pairing.
6. Please try to pair the device in the compatible mode.

Wi-Fi devices "Offline" issues

Please check the following issues by the Wi-Fi LED indicator status:

The LED indicator blinks once every 2s means you fail to connect to the router.

1. Maybe you entered a wrong Wi-Fi SSID and password.
2. Make sure your Wi-Fi SSID and password don't contain special characters, for example, the Hebrew, Arabic characters. Our system can't recognize these characters so that fail to connect to the Wi-Fi.
3. Maybe your router has a lower carrying capacity.
4. Maybe the Wi-Fi signal strength is weak. Your router is too far away from your device, or there may be some obstacles between the router and the device so that the signal transmission is blocked.
5. Be sure that the MAC of the device is not on the blacklist of your MAC management.

The LED indicator flashes twice on repeated means you fail to connect to the server.

1. Make sure the Internet connection is normal. You can use your phone or PC to connect to the Internet, and if you fail to access, please check the availability of the Internet connection.
2. Maybe your router has a low carrying capacity. The number of devices connected to the router exceeds its maximum value. Please check the maximum number of devices that your router can carry. If the number of connected devices exceeds the maximum value, please delete some devices or change a larger router and try again.
3. Please contact your ISP and confirm our server address is not shielded:
cn-disp.coolkit.cc (China Mainland)
as-disp.coolkit.cc (in Asia except China)
eu-disp.coolkit.cc (in EU)
us-disp.coolkit.cc (in US)

If none of the above methods solved this problem, please submit your issue via help & feedback on the eWeLink App.

Hereby, Shenzhen Sonoff Technologies Co., Ltd. declares that the radio equipment type DUALR3, DUALR3 Lite are in compliance with Directive 2014/53/EU. The full text of the EU declaration of conformity is available at the following internet address:

<https://sonoff.tech/usermanuals>

The logo features the word "SONOFF" in a bold, black, sans-serif font. Above the letter "O" are three curved lines representing radio signal waves.

Shenzhen Sonoff Technologies Co., Ltd.

1001, BLDG8, Lianhua Industrial Park, shenzhen, GD, China
ZIP code: 518000 Website: sonoff.tech

MADE IN CHINA

