

SONOFF

ZBMINI Extreme

User manual V1.1

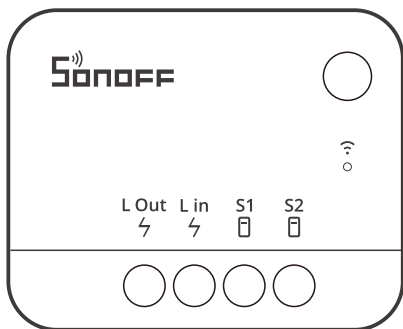

Zigbee Smart Switch

(No Neutral Required)

Product introduction

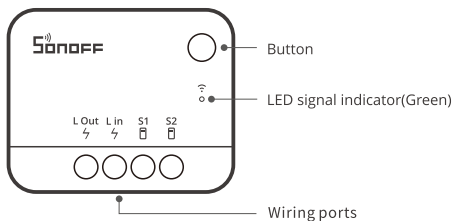

ⓘ The device weight is less than 1kg, and the recommended installation height is less than 2m.

LED indicator status instruction

LED indicator status	Status instruction
Green LED indicator slow flashes	Pairing mode
Green LED indicator keeps on (Relay is powered on)	Device is on line
Green LED indicator quick flashes (Relay is powered on)	Abnormal network connection ZBMINI Extreme and router connect normally, but router and the hub are disconnected
Green LED indicator slow flashes (Relay is powered on)	Abnormal network connection Slow flashing under non-pairing state: ZBMINI Extreme and the parent device are disconnected

Features

SONOFF Zigbee smart switch (No neutral required) allows you to remote control, schedule on/off and set smart scenes to trigger other devices, etc. by connecting Zigbee hub.



Remote Control



Single/Countdown
Timing



Voice Control



OTA Upgrade



Smart Scene



External Switch



Power on State



Camera Linking

ⓘ Above functions are determined by the connected Zigbee Hub.

Installation

1. Power off

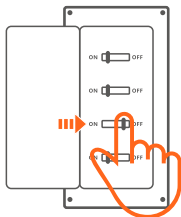

⚠ Please install and maintain the device by a professional electrician. To avoid electric shock hazard, do not operate any connection or contact the terminal connector while the device is powered on!

2. Wiring instruction

To ensure the safety of your electrical installation, it's essential either a Miniature Circuit Breaker (MCB) or a Residual Current operated Circuit-breaker with Integral Overcurrent protection (RCBO) with an electrical rating of 6A has been installed before the ZBMINIL2.

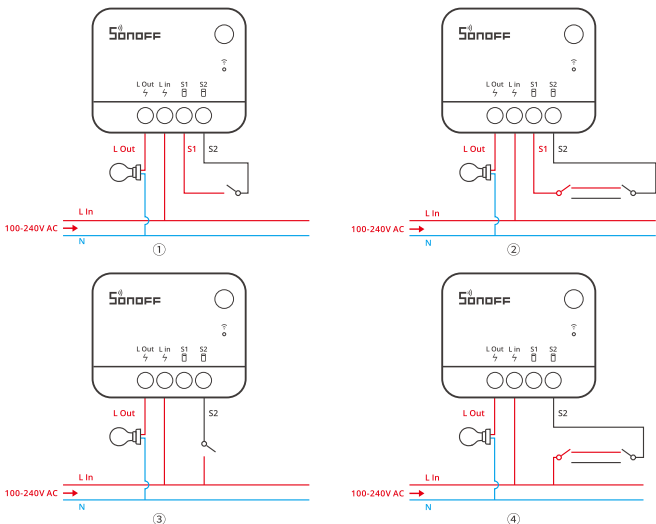

⚠ For the above ③④ wiring methods, please ensure the proper wiring and powering of the L in terminal, otherwise it will cause the device to work abnormally.

- ⓘ Supported switches are rocker switch and push button and factory default by supporting rocker switch.
- ⓘ Unsupported to use with other Inductive loads such as fan.
- ⓘ Make sure all wires are connected correctly.

Pair with eWeLink App

1. Download the eWeLink App



2. Pair SONOFF Zigbee Bridge to your eWeLink account

3. Power on

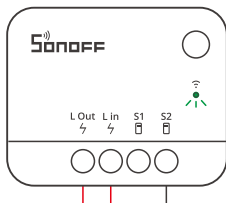

After powering on, the device will enter the pairing mode defaulted during the first use and the green LED indicator will "flash slowly".

- ⓘ The device will exit the pairing mode if you do not operate it within 3mins. If you want to enter the pairing mode again, press and hold the button of the device for 5 seconds until the green Led indicator "flashes slowly" and releases.
- ⓘ The device will remain off and cannot be controlled by the device's button or external switch when it is in pairing mode.

4. Add ZBMINI Extreme to the ZB Bridge

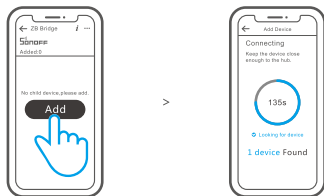

Open eWeLink App, tap "Add" icon on the ZB Bridge interface, then wait to looking for and add the sub-devices.

Pair with Amazon Echo

1. Download the latest Amazon Alexa App and pair it with Amazon Echo with built-in Zigbee hub.
2. Power on ZBMINI Extreme, then it defaulted to enter the pairing mode and the green LED indicator "flashes slowly".

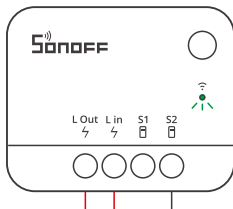

⚠ The device will remain off and cannot be controlled by the device's button or external switch when it is in pairing mode.

3. Ask the Alexa Echo to discover the devices automatically by saying "Alexa, discover my devices".

⚠ If failed to pair within 3mins, ZBMINI Extreme will exit the pairing mode. Long press the button on ZBMINI Extreme for 5s to make it enter the pairing mode if you need to pair again.

Switch the device to the corresponding switch

The device supports rocker switch by default. If you want to change the switch type, press the button 3 times and see the green Led indicator flash 3 times quickly, then the switch type is switched successfully.

⚠ Please switch to the corresponding switch type before installing the device in the mounting box.

Install the ZBMINI Extrene in the mounting box

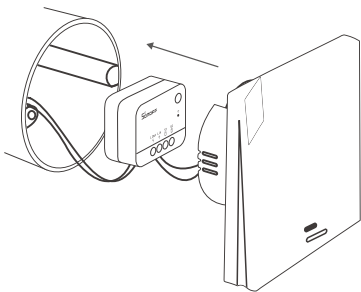

Specifications

Model	ZBMINIL2
Input	100-240V AC 50/60Hz 6A Max
Output	100-240V AC 50/60Hz 6A Max
Max. load	 Resistive load: 6A Max LED: 150W Max @100V, 300W Max @240V
Wireless connection	Zigbee 3.0
Working temperature	-10~40°C
Casing material	PC V0
Product Size	39.5x32x18.4mm

Factory reset

Return the device to its factory settings in any following ways (Device will enter the pairing mode automatically after resetting)

1. Press 10 consecutive times the connected external switch
2. Long-press the device for 5s.
3. Delete the sub-device on eWeLink App

Supported voice assistant



FCC compliance statement

1.This device complies with part 15 of the FCC Rules. Operation is subject to the following two conditions:

- (1) This device may not cause harmful interference, and
- (2) This device must accept any interference received, including interference that may cause undesired operation.

2.Changes or modifications not expressly approved by the party responsible for compliance could void the user's authority to operate the equipment.

Note: This equipment has been tested and found to comply with the limits for a Class B digital device, pursuant to part 15 of the FCC Rules. These limits are designed to provide reasonable protection against harmful interference in a residential installation. This equipment generates, uses and can radiate radio frequency energy and, if not installed and used in accordance with the instructions, may cause harmful interference to radio communications. However, there is no guarantee that interference will not occur in a particular installation. If this equipment does cause harmful interference to radio or television reception, which can be determined by turning the equipment off and on, the user is encouraged to try to correct the interference by one or more of the following measures:

- Reorient or relocate the receiving antenna.
- Increase the separation between the equipment and receiver.
- Connect the equipment into an outlet on a circuit different from that to which the receiver is connected.
- Consult the dealer or an experienced radio/TV technician for help.

FCC Radiation Exposure statement:

This equipment complies with FCC radiation exposure limits set forth for an uncontrolled environment.

This equipment should be installed and operated with minimum distance of 20 cm between the radiator and your body.

This transmitter must not be co-located or operating in conjunction with any other antenna or transmitter.

ISED Notice

This device contains licence-exempt transmitter(s)/receiver(s) that comply with Innovation, Science and Economic Development Canada's licence-exempt RSS(s). Operation is subject to the following two conditions:

- (1) This device may not cause interference.
- (2) This device must accept any interference, including interference that may cause undesired operation of the device.

This Class B digital apparatus complies with Canadian ICES-003(B).

This device complies with RSS-247 of Industry Canada. Operation is subject to the condition that this device does not cause harmful interference.

L'émetteur/récepteur exempt de licence contenu dans le présent appareil est conforme aux CNR d'Innovation, Sciences et Développement économique Canada applicables aux appareils radio exempts de licence. L'exploitation est autorisée aux deux conditions suivantes :

- (1) L'appareil ne doit pas produire de brouillage;
- (2) L'appareil doit accepter tout brouillage radioélectrique subi, même si le brouillage est susceptible d'en compromettre le fonctionnement.

Cet appareil numérique de la Classe B conforme à la norme NMB-003(B) du Canada.

Cet appareil est conforme à la norme RSS-247 d'Industrie Canada. Le fonctionnement est soumis à la condition que cet appareil ne provoque pas d'interférences nuisibles.

ISED Radiation Exposure Statement

This equipment complies with ISED radiation exposure limits set forth for an uncontrolled environment.

This equipment should be installed and operated with minimum distance of 20 cm between the radiator and your body.

This transmitter must not be co-located or operating in conjunction with any other antenna or transmitter.

Cet équipement est conforme aux limites d'exposition aux rayonnements de la ISED établies pour un environnement non contrôlé.

Cet équipement doit être installé et fonctionner à au moins 20cm de distance d'un radiateur ou de votre corps.

Cet émetteur ne doit pas être co-localisé ou fonctionner en conjonction avec une autre antenne ou un autre émetteur.

For CE Frequency

Operation frequency Range

Zigbee: 2405-2480MHz

RF output Power

Zigbee: $\leq 13\text{dBm}$

SAR Warning

Under normal use of condition, this equipment should be kept a separation distance of at least 20 cm between the antenna and the body of the user.

Dans des conditions normales d'utilisation, cet équipement doit être maintenu à une distance d'au moins 20 cm entre l'antenne et le corps de l'utilisateur.

WEEE Disposal and Recycling Information



All products bearing this symbol are waste electrical and electronic equipment (WEEE as in directive 2012/19/EU) which should not be mixed with unsorted household waste. Instead, you should protect human health and the environment by handing over your waste equipment to a designated collection point for the recycling of waste electrical and electronic equipment, appointed by the government or local authorities. Correct disposal and recycling will help prevent potential negative consequences to the environment and human health. Please contact the installer or local authorities for more information about the location as well as terms and conditions of such collection points.

EU Declaration of Conformity

Hereby, Shenzhen Sonoff Technologies Co., Ltd. declares that the radio equipment type ZBMINIL2 is in compliance with Directive 2014/53/EU. The full text of the EU declaration of conformity is available at the following internet address:

<https://sonoff.tech/compliance/>

Scatola	Manuale
PAP 21	PAP 22
Carta	Carta
RACCOLTA	
Verifica le disposizioni del tuo Comune. Separa le componenti e conferiscile in modo corretto.	

SONOFF

Shenzhen Sonoff Technologies Co., Ltd.
3F & 6F, Bld A, No. 663, Bulong Rd, Shenzhen, GD, China
ZIP code: 518000 Website: sonoff.tech
Service email: support@itead.cc
MADE IN CHINA



Points de collecte sur www.quefairedemesdechets.fr
Privilégiez la réparation ou le don de votre appareil !

